



A R K T U R A

Vapor[®] Solid



Ceiling & Wall **Panels**

Our Key Features

Bring forth stunning textural vision with the endless possibilities of Vapor® Solid. These 2'x4' Torsion spring ceiling, and Vertika® Wall panels flow continuously throughout, transitioning from wall to ceiling, allowing you to cover any space thanks to easy installation and accessibility. These solid panels come in a wide array of powder-coated finishes with multiple color and metallic options to mix and match with other Vapor® patterns, or create a Mondrian style installation with color blocking. Optional inline lighting accessories are available to further customize your projects intent.



Superior Flatness & Strength

Vapor® panels are manufactured from aluminum that is on average 50% thicker than the competition, which in combination with our precision processes result in unrivaled flatness.

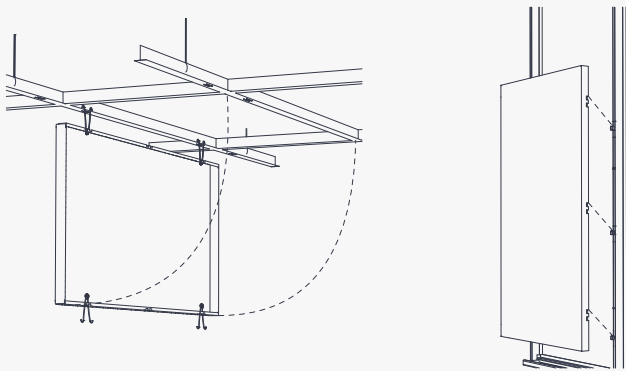

Easy Installation & Access

Vapor® panels offer easy install, using quick torsion spring attachment across standard ceiling grid systems or simple wall attachment using our Vertika® channel system.

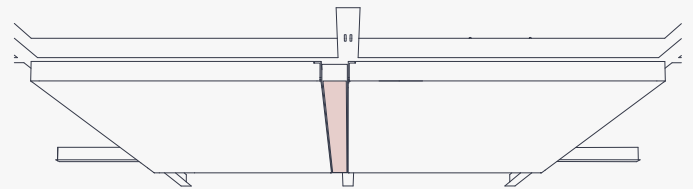

Integrated InLine Option

Arktura's Solid Panels makes it easy to seamlessly add illumination through linear integrated InLine lighting.

Inspiration



Seamless and Dynamic Wall to Ceiling Transitions



Easy Install with Access to Vital Building Infrastructure

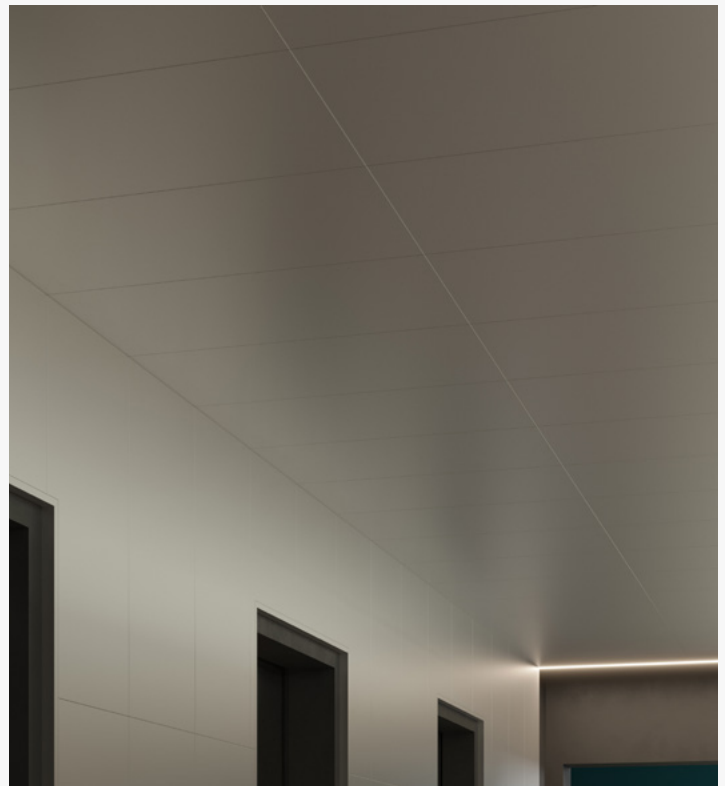

Seamlessly Scalable to Fit Any Size Project

Overview

- 1 Understanding the System
- 2 Optional Accessories
- 3 Available Finishes
- 4 Product Specifications

1 Understanding the System

Standard Panel

Vapor® is a modular accessible aluminum panel system designed to work with torsion grid. Customization is available.

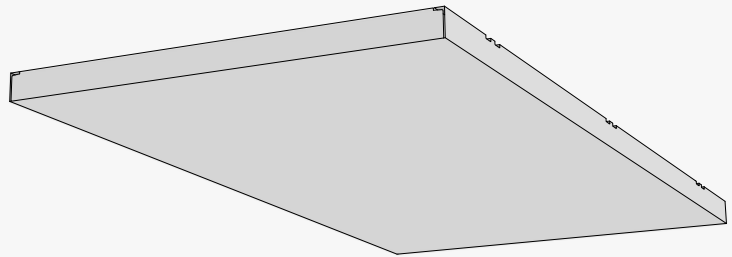

Seamlessly Join Walls & Ceilings

Vapor® easily transitions from one plane to another and around corners.

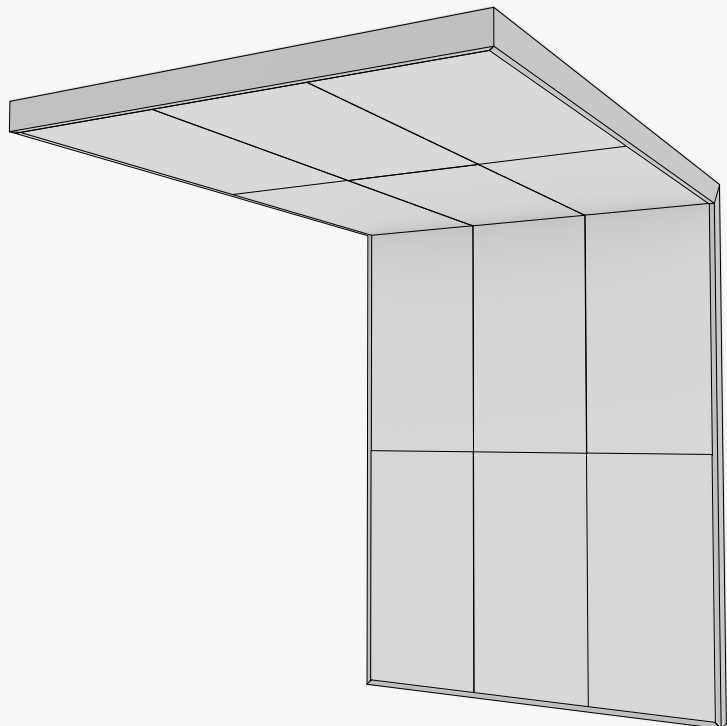

1 Understanding the System

Understanding the Panel

The pattern surface is created by seamlessly tiling across your space.

Panel A: 0% Open

*Vertika® Trim

Ceiling Section

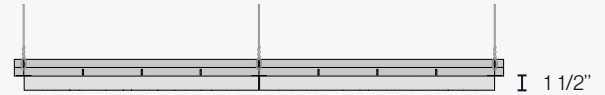

Panel Configuration, Wall or Ceiling

Wall Section

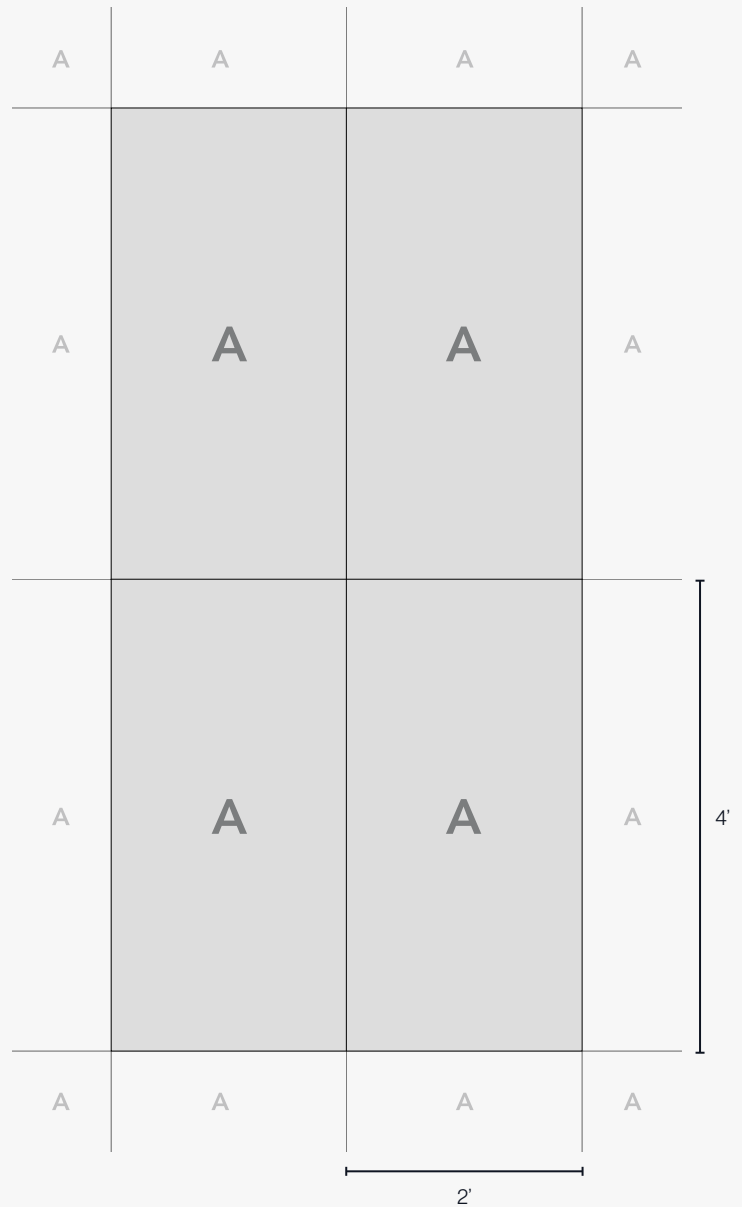
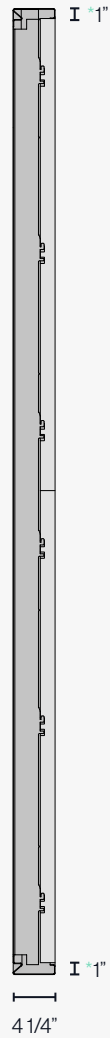

! All dimensions nominal.

1 Understanding the System

Accessory Options - Ceiling

• InLine downlight

* A Specific Inline light panel is used to accommodate the width of the fixture within the 2' width.

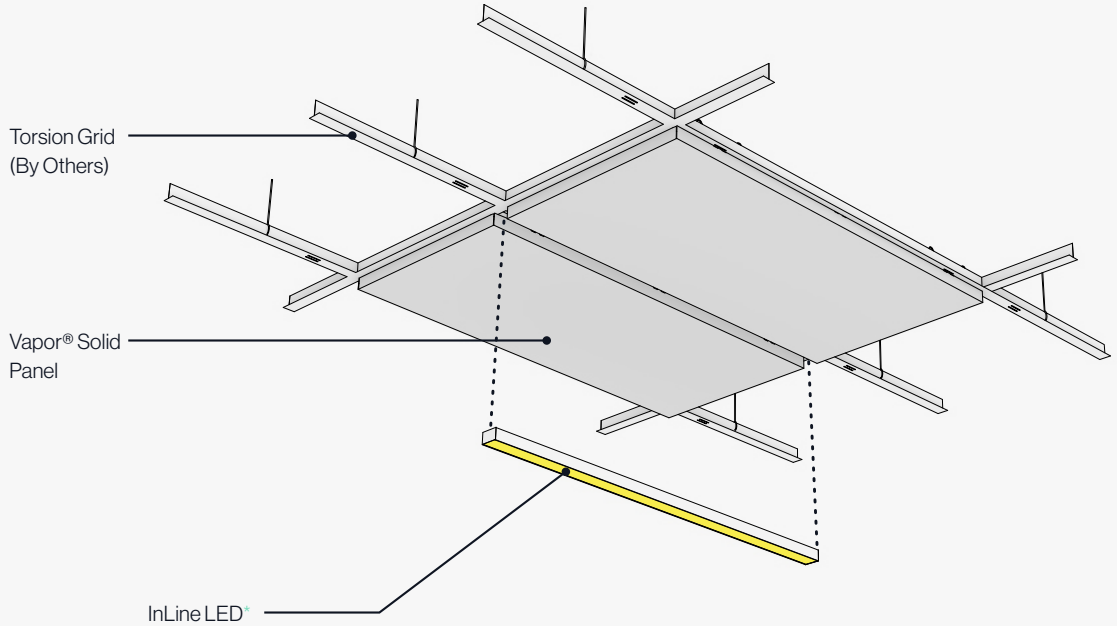

Torsion Spring Adapter Clip

Interested in using standard t-grid? Use our optional Torsion Spring Adapter Clip.

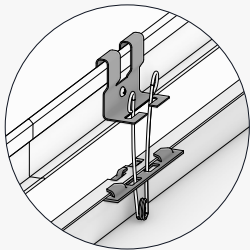

Attachment System - Ceiling

Torsion Spring clips allow for rapid install and easy access for maintenance above the grid post install.

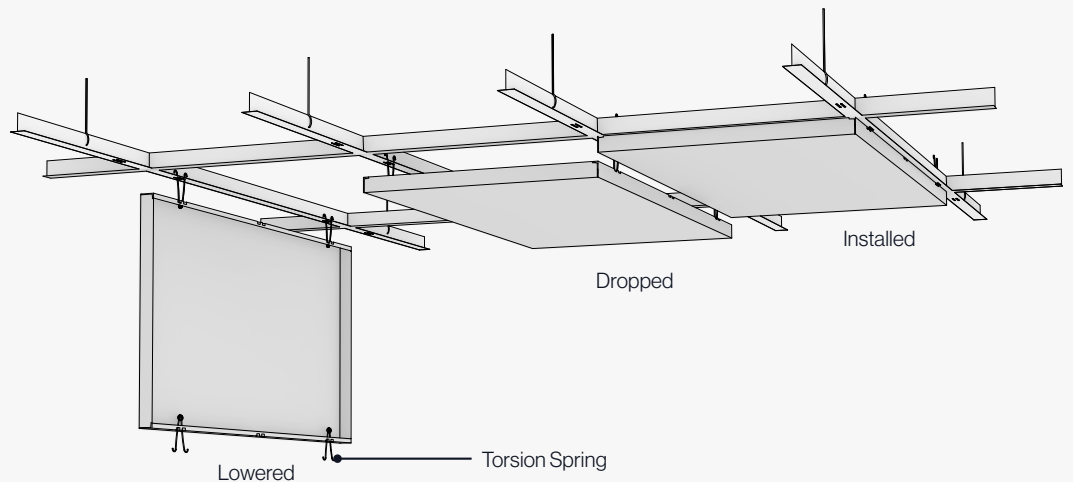

1 Understanding the System

Accessory Options - Wall

- InLine light

* A Specific InLine light panel is used to accommodate the width of the fixture within the 2' width.

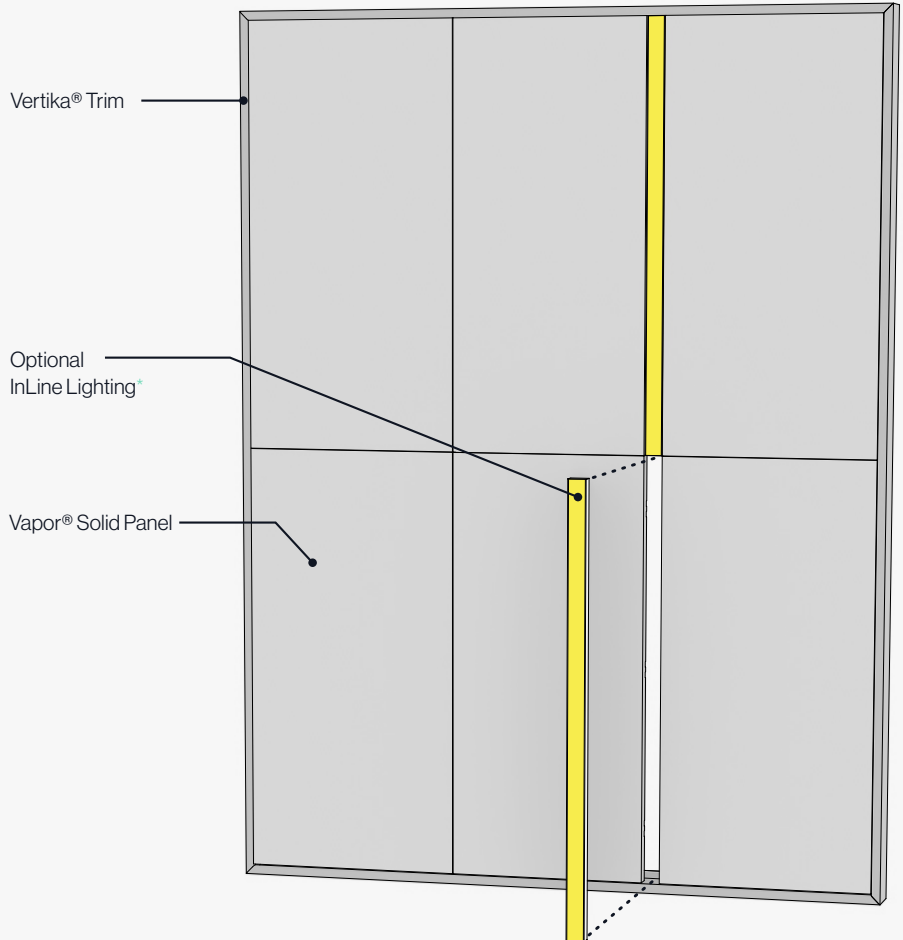

Attachment System - Wall

Panels are easily installed or removed by sliding onto or lifting off from the system's Vertika® channel hooks.

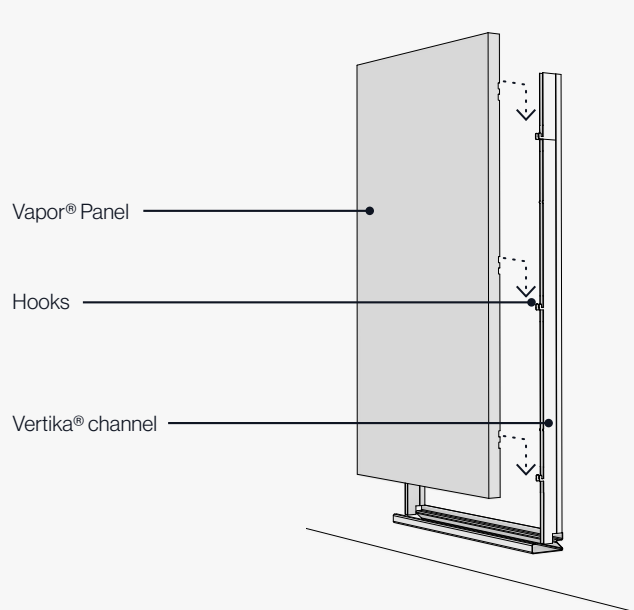

3 Available Finishes

Aluminum Panel

Powder Coat Standard Finish



T-Grid White*
(Matte)

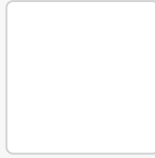

Arktura White
(Matte)

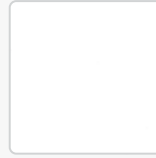

Brilliant White
(Gloss)

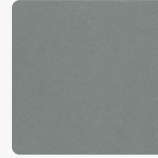

Silver Metallic
(Semi Gloss)

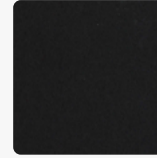

Jet Black
(Matte)

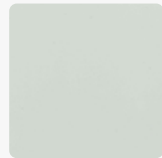

Aviator Gray
(Gloss)

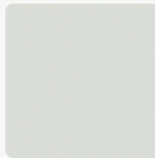

Aviator Gray
(Matte)

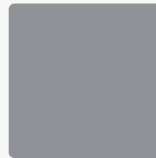

Steel Gray

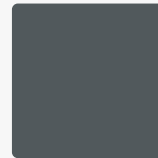

Shadow

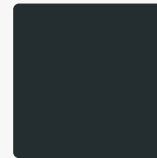

Midnight



Coffee



Raw Umber

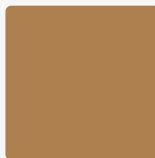

Caramel



Sandstone

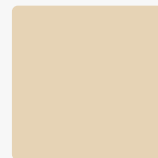

Oat



Sunflower



Torch

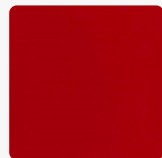

Spirit Red
(Matte)



Azure



Blue Steel



Forest Green

Powder Coat Premium Metallic Finish

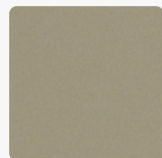

Chilled Champagne
(Semi Gloss)

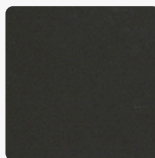

Burnished Bronze
(Semi Gloss)

Custom Powder Colors

We offer premium non-stock RAL and custom color match options as well. Contact your sales rep for more information.

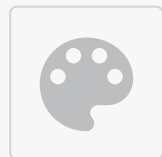

Non-stock
RAL

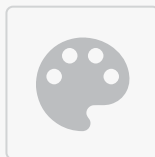

Non-stock
Metallic

* This color was designed to pair with Armstrong color "WH" grid and trim.

ⓘ All premium and standard finishes shown are designed for interior specifications. Products may be specified for exterior use, and with all treatments required by local code or facility, including custom color match or specialty finishes. Any changes to specification from interior standard or interior premium will result in a custom powder coat fee.

4 Product Specifications & Certifications

System Specs

Panel Size (WxHxD)	2' x 4' x 1 1/2"
Material	Aluminum
Openness in Plan	0%
Fire Rating	ASTM E84 - Class A
Ceiling Attachment	Torsion Grid (By Others)
Wall Attachment	Vertika® Wall (Refer to Vertika® Brochure)
Accessibility	Torsion Spring Hinge
Trimmability	Yes, per installation manual
Optional Accessories	InLine Light

Patent Pending
Copyright ©2021-2022 Arktura LLC. All rights reserved.

Lighting Specs

Arktura InLine Lighting

Makes it easy to seamlessly integrate linear lighting into the design of your paneling.

Ceiling

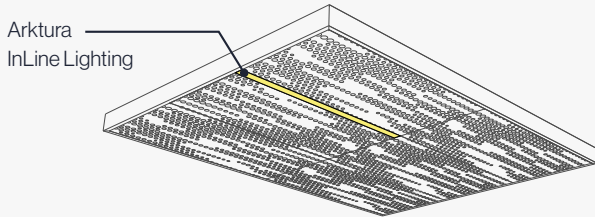

Elevations

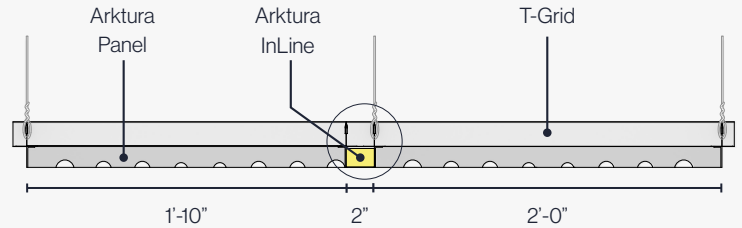

Vertika® Wall

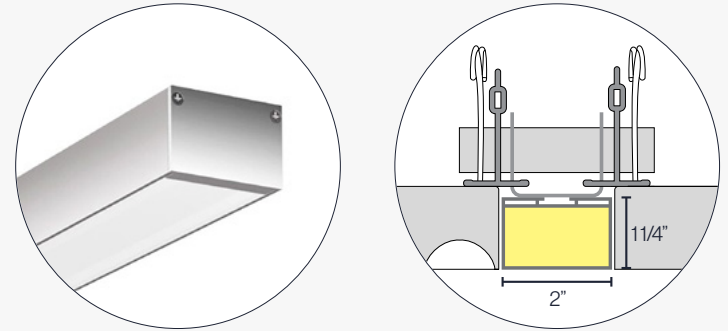
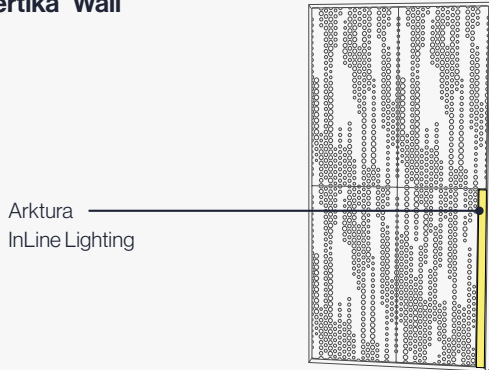

Side - Length Options

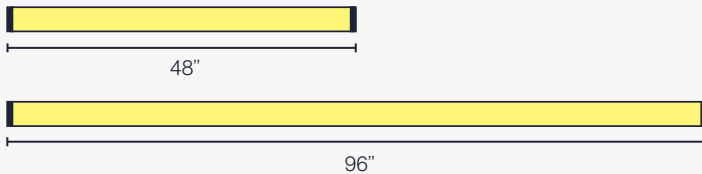

Photometric

Located At Horizontal Angle = 0, Vertical Angle = 0
 # 1 - Vertical Plane Through Horizontal Angles (0 - 180) (Through Max. Cd.)
 # 2 - Horizontal Cone Through Vertical Angle (0) (Through Max. Cd.)

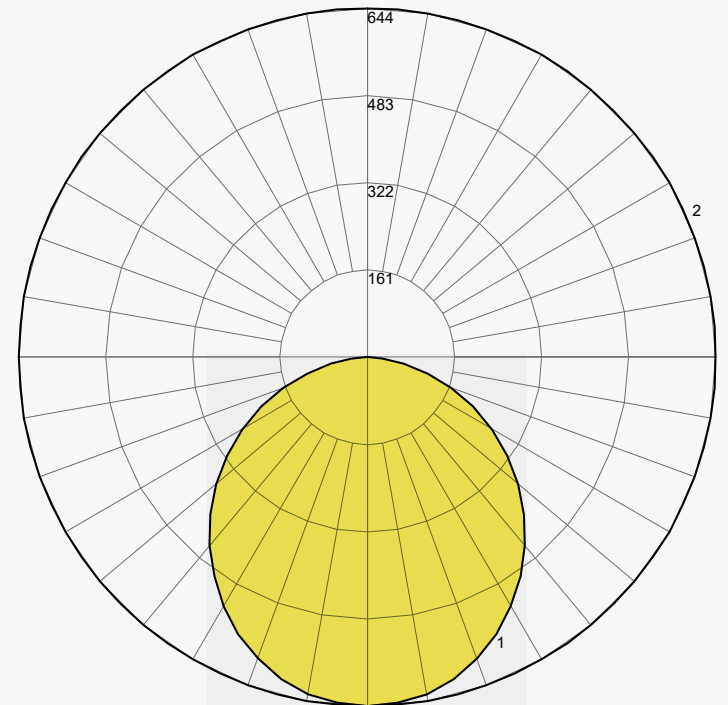

Specs

Product Features	Arktura InLine Eco	Arktura InLine
Total Lumens	640 Lm/Ft	1280 Lm/Ft
Delivered Lumens	480 Lm/Ft	960 Lm/Ft
Power Consumption	6W/Ft	12W/Ft
CRI	95+	
Color Temperatures	3000K, 3500K, 4000K	
Size (LxWxD)	48" x 2" x 1.25", 96" x 2" x 1.25"	
UL Rating	Recognized	
Voltage	24 Volts	
Dimming Options	MLV, 1-10V, 0-10V	
Plenum Rated Wire	Standard	

Product Line

Design Options

Vapor® offers a growing library of metal panels in preconfigured seamlessly tileable patterns that can also be mixed and matched as desired. For additional acoustic performance, take a look at our Soft Sound® faced VaporSoft®.



VAPOR® TRAIL



VAPOR® PIXEL



VAPOR® CUMULA



VAPOR® BYTE

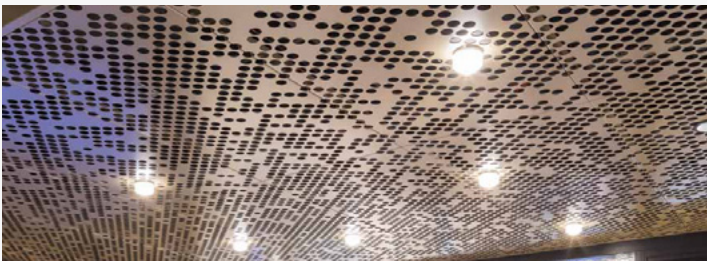

VAPOR® CLUSTER



VAPOR® SYNTAX

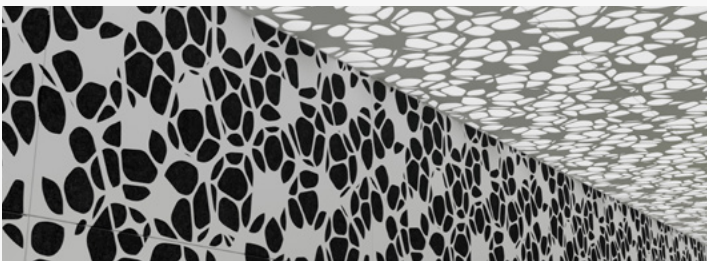

VAPOR® SHIFT

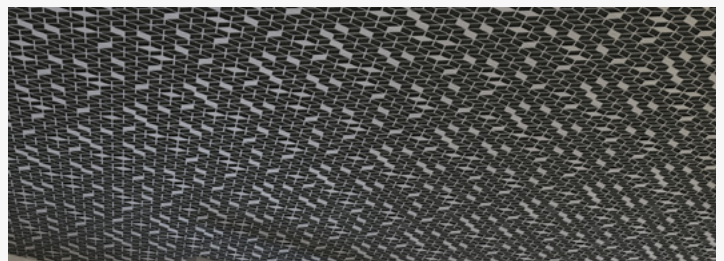

VAPOR® CORA

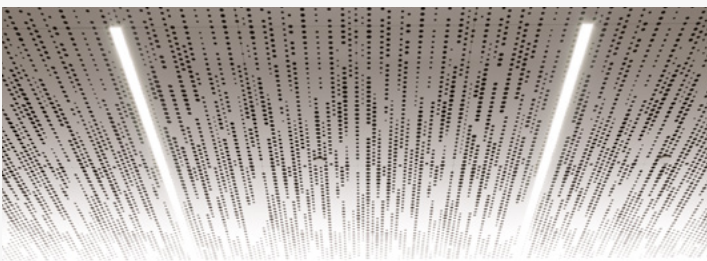

VAPOR® FREQUENCY



VAPOR® LIANA

Product Line

Design Options



VAPOR® SKY

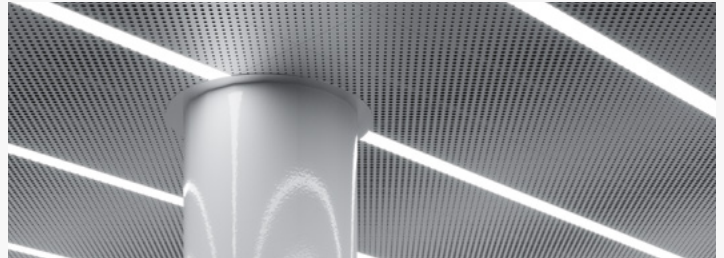

VAPOR® GRADIENT



VAPOR® ELEMENT



VAPOR® BLOOM



VAPOR® BREEZE

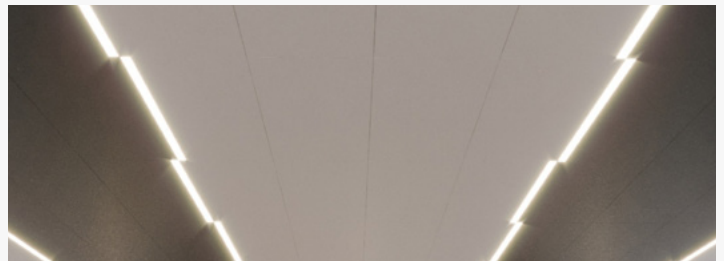

VAPOR® SOLID

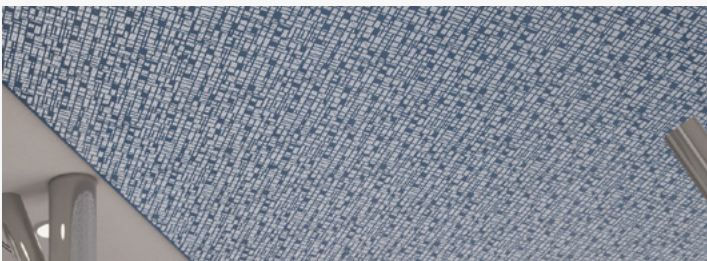

VAPOR® TRANSIT

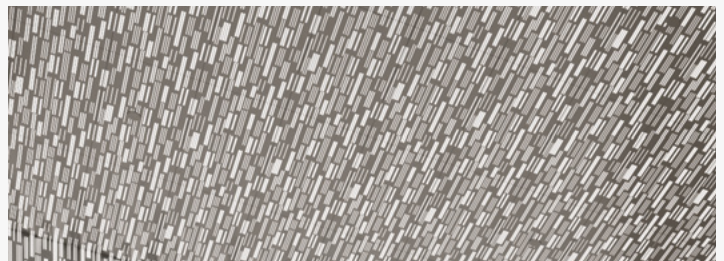

VAPOR® VERVE

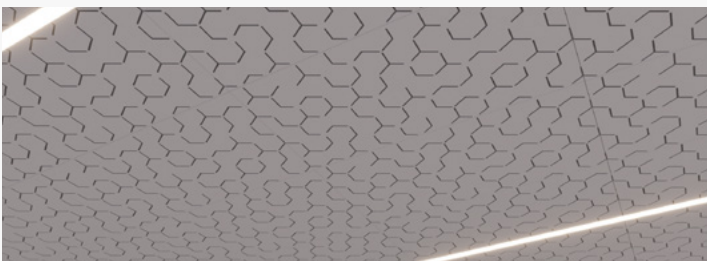

VAPOR® BOND